

Product Name :Electronic Components / Solenoid (DIN) Connectors / Socket / ME-209SL
Product Code : ME-209SL



Features

Protection class : IP-65

Flame Retardant material

Vibration Proof Interlocking

Product range with Protection Circuits & Rectifiers

Product range available in Transparent Casing & optical indicators

BASIC DIMENSIONS

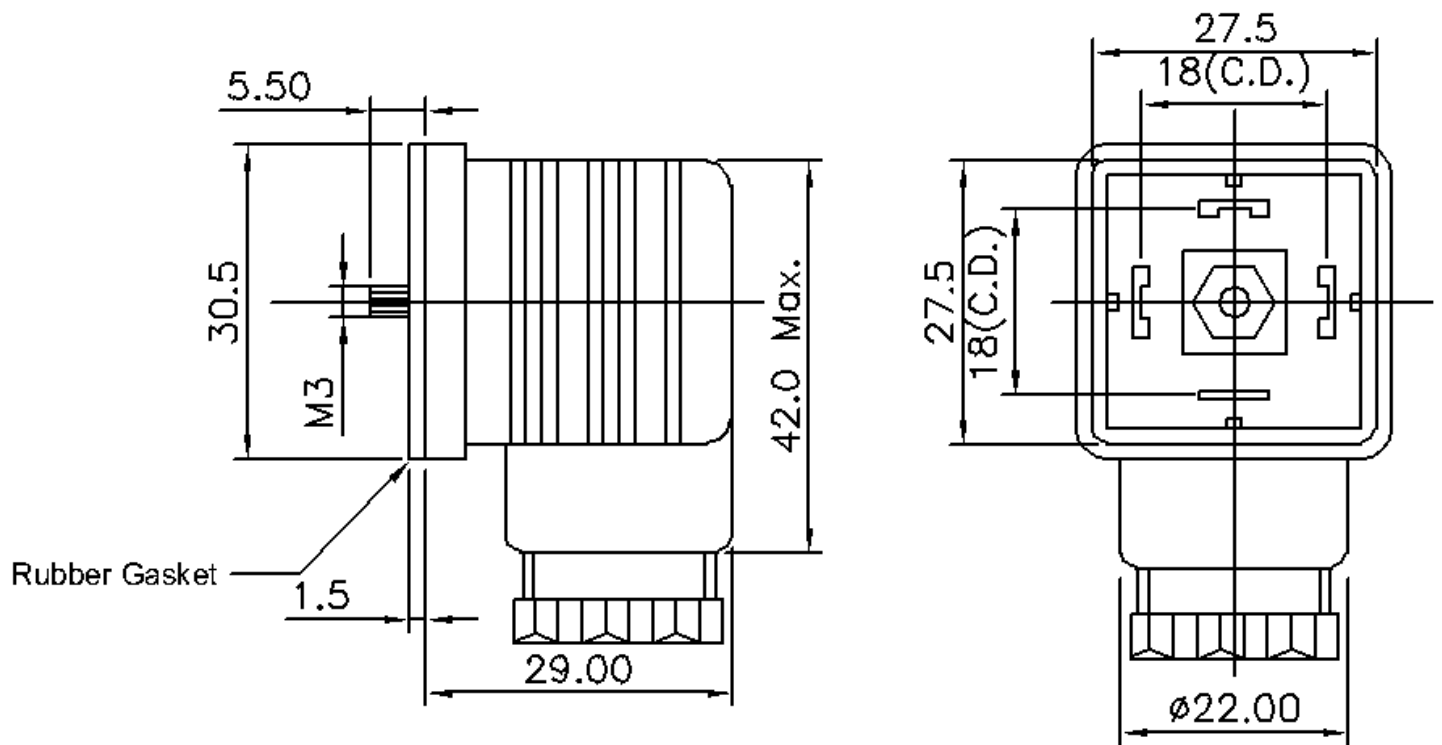



Specifications

Sr.No	Parameter		Specification
1	Product Category / Description		DIN Connector
2	Type / Sub Type		Socket
3	Sub Type		Construction Type A
4	Gender		Female
5	Cable Gland Size		PG9
	Electrical Characteristics		
6	V/A Rating (Non- illuminated)		10 A, 250VAC
7	Insulation Resistance at 500 VDC		100 M ohms Min.
8	H.V.Break Down Test (For 1-Minute)		2 KVAC
9	Contact Resistance (Initial)		20 m ohms Max
10	Indicating Light		Yes
11	Voltage Rating (illuminated)		12VDC, 24VDC, 48VDC, 110VAC, 230VAC
	Operating / Functional Characteristics		
12	Permissible Temperature	With/Without Load	0 To 90°C
13	Mounting		Screw Mounting
14	Terminals (Standard)		Screw - Type
15	Pole Format		2 Pole + Earth
	Material		
16	Body		Nylon
17	RoHS compliant		No (Variety Available Through another code)
18	Colour (Standard)	Colour	Black
19	Current Carrying Parts	(b) Contacts, Terminals	Cu Alloy, Tin Plating
20	Gasket		Nitrile
	Reference Standards / Safety Approvals		
21	Reference Standard		DIN-43650, ISO 4400, DIN EN-175301-803

ANNEXURE A

Standard Variety (2P + E)				
Sr.no.	With Reference To	Available option	RoHS/Non RoHS	Safety Approvals & / Or Markings
1	Plastic Resin	Nylon	Non RoHS	—
2	Gland Size	PG-9	—	—

Other Customized Options Available On Request , Subject To MOQ & Commercial Acceptance.				
Sr.no.	With Reference To	Available options	RoHS/Non RoHS	Safety Approvals & / Or Markings
3	Connection Type	3P + E	Non RoHS	—
4	Plastic Resin			—
5	Gland Size	PG-11	—	—
6	Safety Approval	Nylon 6 FR V-2	