

PRODUCT CODE:-

ERS-20 Series

CATEGORY:-

ROTARY SWITCH

BASIC DIMENSIONS:-

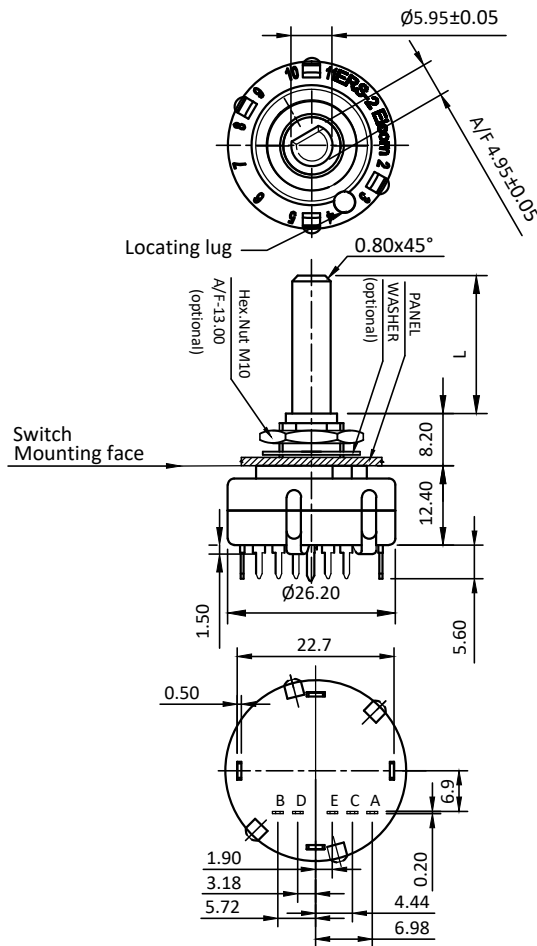

PANEL CUTOUT

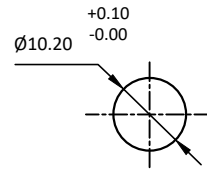

SPECIFICATION TABLE:-

SR.NO	PARAMETER	SPECIFICATION
1	Type	Binary coded Rotary switch, 22.5° Indexing
2	V/A Rating	150mA, 50V AC/DC
3	Non Switching current rating	500 mA
4	Panel Thickness	3mm max.
5	Contact Resistance(Initial)	50 m Ohms. Max.
6	Insulation Resistance at 500 V DC	25000 M Ohms
7	H.V.Break Down Test(For 1-Minute)	250V
8	Mounting	Panel With Nut
9	Terminals	Solder-type
10	Breaking Torque	7kg-cm Min
11	Electrical Life	10,000 Cycles min.
12	Permissible Temp.	(a) With/Without Load -25° To 85°C
		(b) For Soldering 270°C for 5 Sec Max.
13	Material	(a) Plastic parts Glass filled Nylon, PBT
		(b) Terminals/ contacts Copper alloy, Silver plated
		(e) PCB Glass epoxy, Gold plated
14	Reference Standard	IEC-61058-1, UL-1054
15	Compliance Marking	CE (On Request)

REV	IS	WAS	DATE	SIGN	APP.	BY	DATE	SIGN
					APP		11.02.05	SBP
					CHK			
					DRN		11.02.05	SNV
<p>UNSP.TOLERANCE DIMNS. IN WT(Gm) SCALE:- PROJECTION SHEET DRAWING NUMBER</p> <p>OVER - 1 10 mm Max. NTS. 1 OF 2</p> <p>UP TO 1 10 - Moulding, plating details as per Bill of Material Unspecified colour is Black, GF:Glass filled.</p> <p>± 0.2 0.3 0.5</p>								
<p>ELCOM Plot E-4, Kagal Five Star MIDC, Kagal, Kolhapur, MH - 416236, India</p> <p>Elcom International Pvt. Ltd. www.elcom-in.com</p> <p>PER S 2 0 1 3 REVISION 0</p>								

F:ENG-08.00

Note: Technical specifications are subject to change without prior notice

Copyright © 2019 by Elcom International Pvt.Ltd, India. All rights reserved



PRODUCT CODE:- **ERS-20 Series**

CATEGORY:- **ROTARY SWITCH**

SIGNAL DIAGRAM

Position No	Terminal (Track) Nos				
	E(common)	A(1)	B(2)	C(4)	D(8)
1	●	●			
2	●		●		
3	●	●	●		
4	●			●	
5	●	●		●	
6	●		●	●	
7	●	●	●	●	
8	●				●
9	●	●			●
10	●		●		●
11	●	●	●		●
12	●			●	●
13	●	●	●	●	●
14	●		●	●	●
15	●	●	●	●	●
16(off)	●				

ACTUATOR DETAILS:-

Code	L	Cross Section	A/F Orientation (Standard:270°)	Product Code
H	17.0	 (D shape)	330°	ERS-2013
J	17.0		307.5°	ERS-2015

Actuator (A/F) Orientation

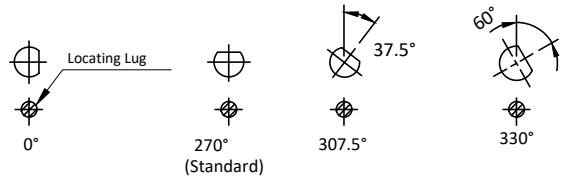

ORDERING CODE:-

Series	Type	No. of Positions	Actuator Code (See Actuator Details)		
ERS	20	(02 -16)	<table border="1"> <tr><td>H</td></tr> <tr><td>J</td></tr> </table>	H	J
H					
J					

For Example:-

ERS-2013-H

ERS-2015-J

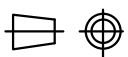
APP	11.02.05	SBP	 Plot E-4, Kagal Five Star MIDC, Kagal, Kolhapur, MH - 416236, India Elcom International Pvt. Ltd. www.elcom-in.com													
CHK																
DRN	11.02.05	SNV														
REV	IS	WAS		DATE	SIGN	APP.	BY	DATE	SIGN							
UNSP.TOLERANCE			DIMNS. IN mm	WT(Gm) Max.	SCALE:- NTS.	PROJECTION	SHEET	DRAWING NUMBER								
OVER	-	1	10				2 OF 2	P	E	R	S	2	0	1	3	REVISION
UP TO	1	10	-	Moulding, plating details as per Bill of Material Unspecified colour is Black, GF:Glass filled.												0
±	0.2	0.3	0.5													

F:ENG-08.00

Note: Technical specifications are subject to change without prior notice

Copyright © 2019 by Elcom International Pvt.Ltd, India. All rights reserved